

KW generators.  
Powerful.  
Innovative.

## KWG-ISO5 Insulation monitor

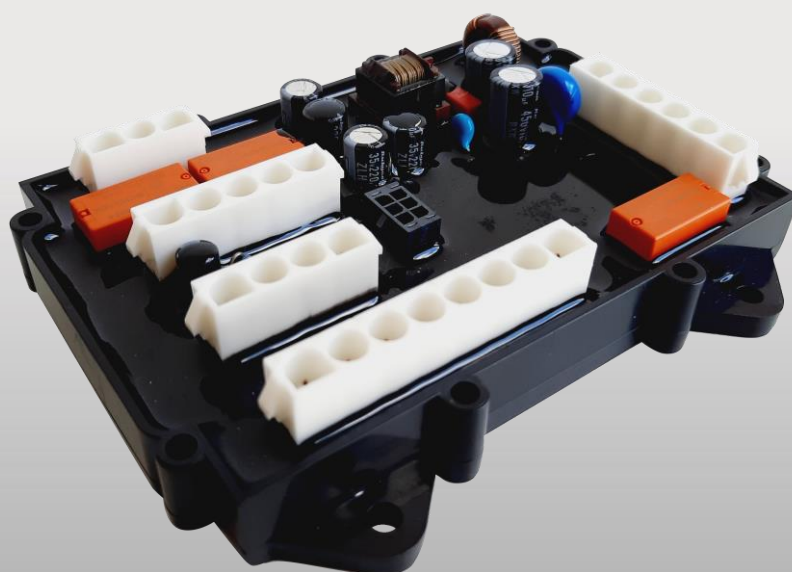

## Imprint

Document type:	Operating Manual		
Document name:	KWG_ISO5_Operating-Manual_V2-0_EN		
Version:	V2.0		
Language:	EN		
Number of pages:	42 Pages		
Created by:	Tim Kurz	Created on:	06.07.2024
Modified by:	Tim Kurz	Modified on:	09.09.2024

## Copyright

Copyright © 2024 KW-Generator GmbH  
All rights reserved.

## Manufacturer address

KW-Generator GmbH  
Bänglesäcker 24  
73527 Schwäbisch Gmünd - Lindach  
Phone +49 (0) 7171 104 17 - 0  
Mail: [info@kw-generator.com](mailto:info@kw-generator.com)  
Internet: [www.kw-generator.com](http://www.kw-generator.com)

## Protective note

Distribution and reproduction of this document, utilisation and communication of its contents are prohibited unless expressly permitted. Infringements will result in compensation for damages. All rights reserved in the event of patent, utility model or design registration.

We expressly reserve the right to make technical changes and improvements.  
In the case of translations into other languages, the German version shall apply in case of doubt.  
No liability is assumed for translations.

## List of changes

<b>Index</b>	<b>Modified by</b>	<b>Stand</b>	<b>Amendment</b>
V1.0	Michael Kurz	10/2021	First edition
V2.0	Tim Kurz	09/2024	New layout; adaptation of texts

## 1 TABLE OF CONTENTS

<b>1</b>	<b>TABLE OF CONTENTS</b>	<b>4</b>
1.1	LIST OF ILLUSTRATIONS	6
1.2	LIST OF TABLES	7
<b>2</b>	<b>FOREWORD AND GENERAL INFORMATION</b>	<b>8</b>
2.1	ABOUT THESE OPERATING INSTRUCTIONS	8
2.2	DISPLAY OF WARNINGS	9
2.3	PRESENTATION CONVENTIONS	10
2.3.1	EXTENDED SYMBOLISM	10
2.4	INTENDED USE OF THE KWG-ISO5	11
2.4.1	STANDARDS AND REGULATIONS	12
2.5	GUARANTEE	12
2.6	GUARANTEE	12
<b>3</b>	<b>SAFETY INSTRUCTIONS</b>	<b>13</b>
3.1	QUALIFICATION OF STAFF	13
3.2	SAFE OPERATION - SAFETY INSTRUCTIONS	13
3.3	SAFE OPERATION - SAFETY RULES	13
3.3.1	SAFETY RULES FOR WORKING ON ELECTRICAL SYSTEMS	14
3.3.2	SAFETY INSTRUCTIONS FOR INSTALLATION, MAINTENANCE AND REPAIR	15
3.4	PERSONAL PROTECTIVE EQUIPMENT	16
<b>4</b>	<b>DESCRIPTION OF THE</b>	<b>18</b>
4.1	GENERAL STRUCTURE	18
4.2	TYPE PLATE	19
4.2.1	TYPE PLATE ON THE KWG-ISO5	19
4.3	TECHNICAL DATA	20
4.4	OVERVIEW OF PROTECTION CLASSES (IP CODE)	22
<b>5</b>	<b>TRANSPORT AND STORAGE</b>	<b>24</b>
<b>6</b>	<b>FUNCTIONAL DESCRIPTION KWG-ISO5</b>	<b>25</b>
<b>7</b>	<b>INSTALLATION AND COMMISSIONING</b>	<b>26</b>
7.1	BEFORE INSTALLATION	27
7.2	AFTER THE INSTALLATION	27
7.3	CIRCUIT DIAGRAM KWG-ISO5	28

7.3.1	KWG-ISO5 OCCUPANCY PLAN	28
7.3.2	KWG-ISO5 PIN ASSIGNMENT	29
7.4	CAN INTERFACE	30
7.4.1	HARDWARE:	30
7.4.2	CAN MESSAGES	30
7.4.3	INTERFACE TO THE KWG ISO-MONITOR / OPTIONAL CURRENT TRANSFORMER EQUIPMENT	32
7.5	ASSEMBLY	33
7.5.1	FLANGE MOUNTING	33
7.5.2	DIN RAIL MOUNTING	33
7.6	CONNECTION OF THE KWG-ISO5	34
7.6.1	ALL-POLE DISCONNECTION WITH TRIPPING DEVICE AND WITH ADVANCE WARNING	34
7.6.2	MONITORING WITH ADVANCE WARNING AND ALARM IN VEHICLES	35
7.6.3	ALL-POLE DISCONNECTION WITH MAIN CONTACTOR AND WITH PRE-WARNING	36
<b>8</b>	<b>MAINTENANCE</b>	<b>37</b>
<b>9</b>	<b>TROUBLESHOOTING</b>	<b>38</b>
9.1	TROUBLESHOOTING	38
<b>10</b>	<b>DECOMMISSIONING, UNINSTALLATION</b>	<b>39</b>
<b>11</b>	<b>REPAIR</b>	<b>40</b>
<b>12</b>	<b>WASTE DISPOSAL</b>	<b>41</b>
<b>13</b>	<b>SPARE PARTS</b>	<b>42</b>

## **1.1 List of illustrations**

Illustration 1: KWG-ISO5 - Structure - Overview Connections .....	18
Illustration 2 Type plate KWG-ISO5 (example).....	19
Illustration 3 KWG-ISO5 allocation plan .....	28
Illustration 4 Assembly - Flange mounting .....	33
Illustration 5 Mounting - DIN rail mounting .....	33
Illustration 6 Connection: All-pole disconnection with tripping device and with pre-warning.....	34
Illustration 7 Connection: Monitoring with advance warning and alarm in vehicles .....	35
Illustration 8 Connection: All-pole disconnection with main contactor and with pre-warning .....	36

## 1.2 List of tables

Table 1KWG-ISO5 Structure Overview .....	18
Table 2: KWG-ISO5 - Explanation .....	19
Table 3Technical data - Mechanical data .....	20
Table 4Technical data - Electrical data - Input .....	20
Table 5Technical data - Electrical data - Measuring circuit.....	20
Table 6Technical data - Permissible climatic conditions .....	20
Table 7Technical data - Regulations .....	21
Table 8Technical data - Relay output data .....	21
Table 9Technical data - Data optocoupler outputs .....	21
Table 10Technical data - CAN connection .....	21
Table 11Technical data - Displays on the circuit board.....	21
Table 12Protection classes - 1st digit: Protection against contact and foreign bodies .....	22
Table 13: Protection classes - 2nd digit: Protection against water .....	23
Table 14Storage and transport conditions .....	24
Table 15KWG-ISO5 pin assignment .....	29
Table 16CAN - Overview .....	30
Table 17CAN - ISO monitor - Status.....	30
Table 18CAN - ISO monitor - Status - Byte .....	30
Table 19CAN - ISO monitor - Status - Byte - Description.....	30
Table 20CAN - STATUS: ISO status message.....	31
Table 21CAN - STATUS: ISO status message - Description .....	31
Table 22CAN - ISO Monitor - Command Test .....	31
Table 23CAN - ISO monitor - Command Reset .....	31
Table 24CAN - ISO Monitor - Command Buzzer Reset .....	32
Table 25CAN - ISO monitor - Cyclic Command - Test, Reset, Buzzer .....	32
Table 26CAN - ISO-Watchdog - Cyclic Command - Test, Reset, Buzzer - Byte .....	32
Table 27CAN - ISO-Watchdog - Cyclic Command - Test, Reset, Buzzer - Byte - Description.....	32
Table 28Connection: All-pole disconnection with tripping device and with pre-warning.....	34
Table 29Connection: Monitoring with advance warning and alarm in vehicles .....	35
Table 30Connection: All-pole disconnection with main contactor and with pre-warning .....	36
Table 31Disposal.....	41

## 2 FOREWORD AND GENERAL INFORMATION

### 2.1 About these operating instructions

These operating instructions refer to the insulation monitors of the KWG-ISO5 series and serve to familiarise you with the insulation monitors and their intended use and to install and operate them safely, properly and efficiently.

The safety and hazard information and the general data apply to all KWG-ISO5 and must always be observed.

Following the instructions in this operating manual helps to avoid hazards, unnecessary repair costs and downtime that could result from incorrect installation or operation. This also ensures high reliability and a long service life for the insulation monitor.

Keep the instructions for the insulation monitor accessible to personnel at all times at the place of use until the product is disposed of.

The persons responsible for the installation, maintenance and servicing of the KWG-ISO5 insulation monitor must have read and understood this manual before installation and commissioning and must follow the instructions given in it. Follow the instructions in this manual at all times during operation of the KWG-ISO5 insulation monitor.

 Chapter "3 Safety instructions".

The operators of the KWG-ISO5 insulation monitor must read and understand the following parts of the operating instructions and follow the instructions given therein before operating the system for the first time:

 Chapter 2 "Foreword and general information" on page 8

 Chapter 3 "Safety instructions" on page 13

 Chapter 4 "Description of the" on page 18

 Chapter 6 "Functional description KWG-ISO5" on page 25

 Chapter 7 "Installation and commissioning" on page 26

 Chapter 8 "Maintenance" on page 37

The KWG-ISO5 insulation monitor may only be installed and used in compliance with all applicable national safety regulations and regulations on accident prevention and environmental protection.

We reserve the right to change the content of this documentation without prior notice. The illustrations do not necessarily correspond to the actual product.

The document is double-sided. The document must therefore be printed double-sided / duplex.



## 2.2 Display of warnings

For better differentiation, hazardous risks are identified in the instructions by the following warning signs and signal words.



### **DANGER**

Disregarding such warnings can lead to serious injury or even death.



### **WARNING**

Disregarding such warnings can lead to serious injury or even death.



### **CAUTION**

Disregarding such warnings can lead to minor to moderate injuries.

### **ATTENTION**



Indicates a potentially harmful situation that can lead to damage to the device or the environment.

### **NOTE**

This information provides you with additional advice and tips to make your work easier.

### 2.3 Presentation conventions

The presentation conventions described below are used:

Name	Representation	Function
Instruction for action 1st level	1), 2) etc.	Prompts an action.
Instruction for action 2nd level	a), b) etc.	Denotes a section in a sequence of actions.
Enumeration in safety instructions	➤	Indicates individual elements of the enumeration in safety instructions.
Enumeration	•	Indicates individual elements of the enumeration.
Emphasis	▪	Indicates important remarks.
Cross reference		Reference within this document to another chapter or to a more detailed document.
Figure reference/table		Reference to a figure or table.

#### 2.3.1 Extended symbolism

##### **1** Definition of components

defines components or parts.

## 2.4 Intended use of the KWG-ISO5

The KWG-ISO5 are components of machines and systems that are intended for industrial and professional use and therefore cannot be treated as retail goods.

The ISO monitors may only be used in accordance with the specifications on the type plate, the data sheet or in accordance with a special approval.

The KWG-ISO5 is encapsulated with a special casting compound. The KWG-ISO5 is protected from moisture and vibrations thanks to the full encapsulation. To achieve the full service life of the system, the KWG-ISO5 should not be exposed to unnecessary vibrations.

### ATTENTION

Moisture and wetness on the circuit board of the KWG-ISO5 or on the circuit board encapsulation can destroy the KWG-ISO5. Outdoor operation or cleaning the switch box or switch cabinet with high-pressure cleaners is strictly prohibited.

The installation space of the KWG-ISO5 must guarantee protection class IP54. To achieve protection class IP54, the KWG-ISO5 must be installed in switch boxes or control cabinets designed for this purpose.

For a definition of the IP protection class, see  chapter 4.4 "Overview of protection classes (IP code)" on page 22.

The KWG-ISO5 monitors the insulation resistance of an unearthed AC system in the wide voltage range from 85 V to 300 V to earth with DC components, which is fed by a KWG generator.

Only one KWG-ISO5 insulation module may be connected in each conductively connected system.

### 2.4.1 Standards and regulations

The KWG-ISO5 are RoHS compliant and fulfil the regulations:

- DIN EN 61557-8
- DIN EN 61326-2-4
- DIN EN ISO 13766-1
- DIN EN 60529

and are intended for networks in accordance with DIN VDE0100-551.

### 2.5 Guarantee

The KWG-ISO5 may only be used for the applications specified here and only in accordance with the information in these operating instructions. KW-Generator GmbH accepts no liability for improper or abusive use of the KWG-ISO5.

No modifications may be made to the KWG-ISO5. Any modification, improper repair or use of unsuitable third-party parts will invalidate any warranty claims. KW-Generator GmbH accepts no liability in this case.

### 2.6 Guarantee

If no special warranty provisions have been concluded in writing for type-related applications and customers, we grant a warranty in accordance with the general European provisions.

## 3 SAFETY INSTRUCTIONS

Always observe the safety instructions listed in this chapter when working with the KWG-ISO5. These are supplemented by additional specific warnings that only apply to certain actions and activities. These specific warnings are indicated at the relevant points in the manual and are highlighted accordingly.

### 3.1 Qualification of staff

Work on the installation, commissioning, operation, inspection, maintenance and repair of plant systems may only be carried out by authorised and qualified specialist personnel.

Qualified personnel are persons who, on the basis of their training, experience and instruction, as well as their knowledge of relevant standards, regulations, accident prevention regulations and operating conditions, have been authorised by the person responsible for the safety of the component/system to carry out the required activities and are able to recognise and avoid potential hazards.

### 3.2 Safe operation - safety instructions

The following safety instructions must be observed when operating the KWG-ISO5.



#### DANGER

Non-compliance with warnings and safety instructions

#### Death or serious injury

- All safety and warning instructions must be followed!
- Before carrying out any work on the appliance, switch it off completely and secure it against unintentional switching on again.
- Do not operate the KWG-ISO5 in potentially explosive atmospheres.
- Never carry out visual inspections for maintenance purposes and cleaning work on the KWG-ISO5 during operation.

#### ATTENTION

With the exception of the switching relays, the KWG-ISO5 is wear-free and maintenance-free. Repairs are impossible due to the fully encapsulated design.

### 3.3 Safe operation - safety rules

The following safety instructions must be observed when installing and carrying out work on the KWG-ISO5.

### **3.3.1 Safety rules for working on electrical systems**

Always follow the five safety rules for working on electrical systems when working on the KWG-ISO5:

- Unlock.
- Secure against switching on again.
- Check that there is no voltage.
- Earthing and short-circuiting.
- Cover or cordon off neighbouring live parts.

### 3.3.2 Safety instructions for installation, maintenance and repair



#### **DANGER**

Non-compliance with warnings and safety instructions

##### **Death or serious injury**

- All safety and warning instructions must be followed!
- Before carrying out any work on the appliance, switch it off completely and secure it against unintentional switching on again.
- Work on electrical systems may only be carried out by trained specialists and in accordance with the applicable national regulations.
- Do not operate the KWG-ISO5 in potentially explosive atmospheres.
- Never carry out visual inspections for maintenance purposes and cleaning work on the KWG-ISO5 during operation.



#### **DANGER**



Dangerous electrical voltage

##### **Death or serious injury due to electric shock**

- Always de-energise the appliance before working on it!
- Work on electrical systems may only be carried out when they are switched off and de-energised. Switched-off drive units must be secured against unintentional restarting (including existing auxiliary circuits).
- Protective panelling must not be removed and protective devices must not be disabled.
- Unauthorised persons, children and animals must not have access to the KWG-ISO5 during and after operation of the KWG-ISO5.

### 3.4 Personal protective equipment

Personal protective equipment is required and must be used for various activities on the appliance/system.

The specialised companies must provide sufficient protective equipment for their personnel and supervisors must check that it is worn.

Command sign	Meaning	Explanation
	Use eye protection M004	Eye protection must be used wherever biological, chemical, thermal, mechanical, optical or electrical hazards occur that can enter the eyes and damage them in a fraction of a second.
	Use foot protection M008	Safety shoes must be used wherever slippery floor coverings, falling or protruding sharp objects, obstacles of any kind, cold, wet, heat, aggressive liquids, dust and much more must be expected. Safety shoes in different categories offer acid-resistant, waterproof, nail penetration-resistant, slip-resistant or heat-resistant soles. Steel toecaps protect the toe area from broken bones, bruises and contusions.
	Use hand protection M009	Safety gloves must be used wherever injuries caused by stabs, cuts, burns or hypothermia as well as other harmful effects, such as substances that can permanently damage the skin and above all severely damage the hands. Under no circumstances should safety gloves be used when working on rotating parts such as drills, etc.
	Use protective clothing M010	Protective clothing must be used wherever special work tasks have to be carried out in extreme working conditions and the body may be damaged. Depending on the design, they can protect the wearer from heat, cold, moisture, vapours, radiation, electrical energy, flames, sparks, flammable liquids and chemical substances. High visibility waistcoats, on the other hand, help to ensure that you are not overlooked.



Command sign	Meaning	Explanation
	Use head protection M014	<p>A safety helmet must be worn wherever falling, swinging, toppling or flying objects are likely to hit your head and cause injury.</p> <p>Long hair can cause serious accidents if it is caught by machines or machine parts. Bonnets, scarves, caps or close-meshed hairnets are therefore required in appropriate work areas.</p>

---

## 4 DESCRIPTION OF THE

### 4.1 General structure

The KWG-ISO5 is designed as a single-board solution and is therefore mouldable.

A  $\mu$ Controller takes over the control and evaluation.

All connections are pluggable. The housing can be flange-mounted or DIN rail-mounted. Enclosures with flange mounting can be fastened with M4 screws (diameter of the fastening holes: 4.5 mm).

The housing is made of impact-resistant plastic in black colour.

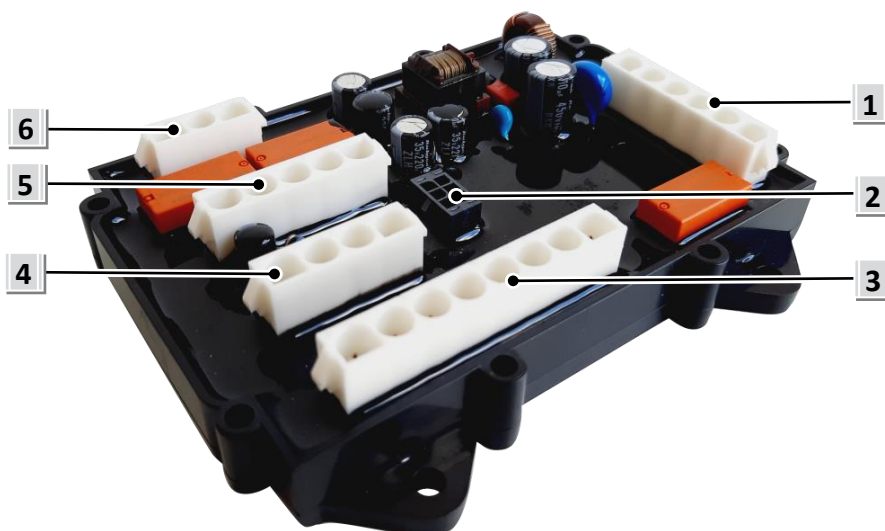

Illustration 1: KWG-ISO5 - Structure - Overview Connections

No	Designation	Function
1	Connector X4	Supply and measuring circuit / alarm - potential-free relay contact
2	Programming plug	Connection for programming the KWG-ISO5
3	Plug X2	Multi I/O and PE
4	Plug X1	CAN connection
5	Plug X5	Buzzer with acknowledgement
6	Plug X3	Warning - potential-free relay contact

Table 1KWG-ISO5 Structure Overview

### NOTE

For a detailed description of the connectors, see [Illustration 3](#) and [Table 15](#).

## 4.2 Type plate

Each KWG-ISO5 has a type designation, serial number, firmware and parameter version. These and other technical details can be found on the type plate.

### NOTE

Please have the type designation, serial number, firmware and parameter version ready in case of queries, repeat orders or spare parts orders.

### 4.2.1 Type plate on the KWG-ISO5

	<b>Un = 230 V</b>	<b>Us = 230 V</b>
<b>AC/DC</b>	<b>fn = 50 Hz</b>	<b>Ran = 23 kOhm</b>
<b>UK CA</b>	<b>Ser.Nr.18157 Jul 10, 2024</b>	
<b>CE</b>	<b>Typ: KWG-ISO5-010-010</b>	
	<b>Firmware: V1.20</b>	<b>Param.:</b>

Description see  Table 2

Illustration 2 Type plate KWG-ISO5 (example)

Explanation of the nameplate data:

Un	Nominal voltage of the IT system to be monitored [V]	
Us	Supply voltage [V]	
fn	Rated frequency [Hz]	
Ran	Response value for alarm [kOhm]	
Ser. no.	Serial number	
date	Date of the examination	
Type	Type designation	
Firmware	Firmware version	
Param.	Parameters (optional)	
LOGOS:	AC/DC	Measuring method
	UKCA	UKCA labelling
	CE	CE labelling

Table 2: KWG-ISO5 - Explanation

### 4.3 Technical data

The following tables provide an overview of the general data of the KWG-ISO5.

If no other data is listed in the type-specific data sheet, the data of the

☰ Table 3 to Table 10 Validity.

<b>Mechanical data:</b>		
Housing dimensions (L x W x H): [mm]	Housing with flange mounting:	122.5 x 103.5 x 25
	Housing with DIN rail mounting:	125.5 x 79 x 43
Weight:	approx. 200 g with housing and potting	
Fastening:	DIN rail or optional flange mounting	
Protection class according to IP rating:	IP20	
Housing material:	ABS 1001 FR	

Table 3 Technical data - Mechanical data

<b>Electrical data - Input:</b>	
Power supply:	85 - 300 V AC
Mains frequency:	18 - 150 Hz
Power consumption:	max. 2.2 W
Protection class	I (with double or reinforced insulation)
Insulation of the circuits - Mains input / output voltages	Overvoltage category I (according to EN 60 010-1) 2.21 kV

Table 4 Technical data - Electrical data - Input

<b>Electrical data - measuring circuit:</b>	
Measuring voltage	± 12 V
Measuring current	≤ 200 µA
Internal resistance DC	≥ 50 kΩ
Permissible external DC voltage	≤ 300 VDC
Permissible system leakage capacitance	≤ 5 µF

Table 5 Technical data - Electrical data - Measuring circuit

<b>Permissible climatic conditions:</b>	
Temperature during operation	-25 °C to +60 °C
Temperature during storage and transport	-30 °C to +85 °C
Air humidity	10% to 93% (condensation without grouting not permitted)
Operating height for mentioned specifications	0 to 2000 m above sea level.

Table 6 Technical data - Permissible climatic conditions

<b>Regulations:</b>	
DIN EN 61557-8	
DIN EN 61326-2-4	
DIN EN ISO 13766-1	
DIN EN 60529	
Table 7 Technical data - Regulations	

<b>Data relay outputs:</b>	
Type: PE014024	4000 Vrms Dielectric strength between contacts and coil
	VDE Cert. No 40011901, UL E2140251
	Rated voltage: 250 VAC (max. 400 VAC)
	Rated current: 5A
	Creepage distance between contacts and coil: > 3.2 mm
Table 8 Technical data - Relay output data	

<b>Data optocoupler outputs:</b>	
Type: HCPL-181-06BE	3750 Vrms Dielectric strength
	DIN EN 60747-5-2, UL1577, CSA A 88324
	200% < CTR < 400%
	I primary: 9.5 mA
	Collector current < 30 mA,
	VCEsat < 0.2 V , tr = 4 μs (typ.)
Table 9 Technical data - Data optocoupler outputs	

<b>CAN connection:</b>	
Speed:	250 kBit/s
Communication:	J1939, galvanically isolated
Terminating resistor:	Not equipped as standard
CAN supply voltage:	12/24 V (range: 9 - 36 V)
Table 10 Technical data - CAN connection	

<b>Displays on the circuit board:</b>	
green LED:	Lights up when ready for operation
Table 11 Technical data - Displays on the circuit board	

## 4.4 Overview of protection classes (IP code)

### NOTE

Enclosed is an extract from the EN 60529 standard (degrees of protection provided by enclosures (IP code)).

Further information on the protection classes can be found in the current version of the EN 60529 standard.

#### Protection against contact and foreign bodies:

1. code number	Designation - Explanation
0	Not protected.
1	Protected against solid foreign bodies 50 mm in diameter and larger: The object probe (50 mm sphere) must not penetrate fully.
2	Protected against solid foreign bodies 12.5 mm in diameter and larger: The object probe (12.5 mm sphere) must not penetrate fully. <u>Note:</u> Typically the ventilation slots in a PC power supply housing,...
3	Protected against solid foreign bodies 2.5 mm in diameter: The object probe (2.5 mm sphere) must not penetrate at all.
4	Protected against solid foreign bodies 1 mm and larger: The object probe (1 mm sphere) must not penetrate at all.
5	Dust-protected: Ingress of dust is not completely prevented, but dust must not penetrate in such quantities that the operation of the appliance or safety is impaired.
6	Dustproof: No ingress of dust with a negative pressure of 20 mbar in the housing.

Table 12 Protection classes - 1st digit: Protection against contact and foreign bodies

**Protection from water:**

2. code number	Designation - Explanation
0	No protection.
1	Protected against dripping water: Vertically falling drops must not have any harmful effects.
2	Protected against dripping water when the housing is tilted up to 15°: Vertically falling drops must not have any harmful effects if the housing is inclined by an angle of up to 15° on either side of the vertical.
3	Protected against water spray: Water sprayed at an angle of up to 60° on either side of the vertical must not have any harmful effects.
4	Protected against splash water: Water splashed against the housing from any direction must not have any harmful effects.
5	Protected against water jets: Water that is directed against the housing as a jet from any direction must not have any harmful effects. <u>Note:</u> Corresponds to approx. 12.5 litres/minute (garden hose). Test period approx. 5 minutes. (Data without guarantee.).
6	Protected against strong water jets: Water directed as a strong jet against the housing from any direction must not have any harmful effects.
7	Protected against the effects of temporary immersion in water: Water must not enter the enclosure in a quantity that causes harmful effects if the enclosure is temporarily submerged in water under standardised pressure and time conditions.
8	Protected against the effects of permanent immersion in water: Water shall not enter in such quantity as to cause harmful effects when the enclosure is continuously immersed in water under conditions agreed between the manufacturer and the user. However, the conditions must be more severe than for code number 7.

Table 13: Protection classes - 2nd digit: Protection against water

## 5 TRANSPORT AND STORAGE

The KWG-ISO5 is supplied ready for installation.

It is recommended that all components are carefully checked for transport damage on arrival at their destination. Any visible damage must be reported immediately to the transport company involved and to KW-Generator GmbH.

The KWG-ISO5 does not require maintenance during storage.

### ATTENTION

**Components may be damaged by moisture.**

- During transport and storage, ensure that all covers and/or packaging are properly closed.
- If the KWG-ISO5 is not put into operation immediately, it must be stored in a protected, clean, dry and vibration-free location.

Permissible temperatures:	
Transport	-30 °C to +85 °C
Storage	-30 °C to +85 °C
Permissible relative humidity:	
Transport	93 %, non-condensing
Storage	93 %, non-condensing

Table 14 Storage and transport conditions



## 6 FUNCTIONAL DESCRIPTION KWG-ISO5

The KWG-ISO5 generates a pulse-shaped measuring voltage. This is superimposed on the IT system to be monitored via terminals L1 / L2 (N) and PE.

Insulation faults between the IT system and earth close the measuring circuit.  
If the value falls below the pre-warning value, the "Warning" relay (connector X3) switches.  
If the value falls below the switch-off value, the "ALARM" relay (connector X4) switches.

The KWG-ISO5 has a self-test function.  
The self-test can be initiated manually at connector X2 by bridging the "T" input (test) to the "R/T/B" input for at least 1.5 seconds.

The internal fault memory can be deactivated or deleted at connector X2 by bridging the "R" input (reset) to the "R/T/B" input.

An additional "Buzzer" relay (connector X5) is activated as soon as the "Warning" status is reached. The relay can be cancelled by bridging the "R-B" input (reset buzzer) on connector X5 with the "R/T/B" input.

The CAN interface (connector X1) offers the option of reading out further data and statuses from the KWG-ISO5 and controlling the ISO monitor.

The PE1 and PE2 connections (connector X2) must be connected.

The KWG-ISO5 is connected using plug connections.

### NOTE

For a detailed overview and description of the connectors, see  
☰ Illustration 1 and ☰ Table 1 and ☰ respectively Illustration 3 and ☰ Table 15.

## 7 INSTALLATION AND COMMISSIONING

This chapter describes the installation and initial commissioning of the KWG-ISO5.

Before installing and commissioning the KWG-ISO5, carefully read the  Chapter 3 "Safety instructions".



### DANGER

Non-compliance with warnings and safety instructions

#### Death or serious injury

- All safety and warning instructions must be followed!
- Before carrying out any work on the appliance, switch it off completely and secure it against unintentional switching on again.
- The KWG-ISO5 may only be operated with correctly fitted protective covers.
- Do not operate the KWG-ISO5 in potentially explosive atmospheres.
- Unauthorised persons, children and animals must not have access to the KWG-ISO5 during and after operation of the KWG-ISO5.
- The system must be equipped with the necessary protective devices in accordance with the statutory regulations.
- The KWG-ISO5 may only be installed by authorised and qualified specialist personnel.



### WARNING

Danger from self-starting machines

#### Death or serious injury

- Only start the system once you have ensured that all the points listed in this chapter have been fulfilled.

## 7.1 Before installation

Before installation, check that:

- the plug connections on the KWG-ISO5 are correctly plugged in and firmly engaged.
- the mechanical assembly is correct.
- the connections on the terminal board/terminal strip are made correctly (if present).
- the connections have been assigned correctly and there are no short circuits.
- the system is disconnected by the main switch or other disconnecting devices.

## 7.2 After the installation

After installing the system, see also  "KWG\_Generator\_Operating-Manual", the function of the KWG-ISO5 must be tested.

For the function test, generate a real insulation fault  $R_F$  to earth using a suitable resistor or test equipment.

Depending on the application, the tripping device or the main contactor must respond after a manual self-test and the function test.

After resetting, the main contactor or the tripping device can be returned to the "ON" position. If this is not the case, check the installation and contact KW-Generator GmbH if necessary.

If an insulation fault occurs during commissioning or at a later time, appropriate troubleshooting is required. For information on troubleshooting, see  chapter 9 - Troubleshooting on page 38.

### 7.3 Circuit diagram KWG-ISO5

#### 7.3.1 KWG-ISO5 occupancy plan

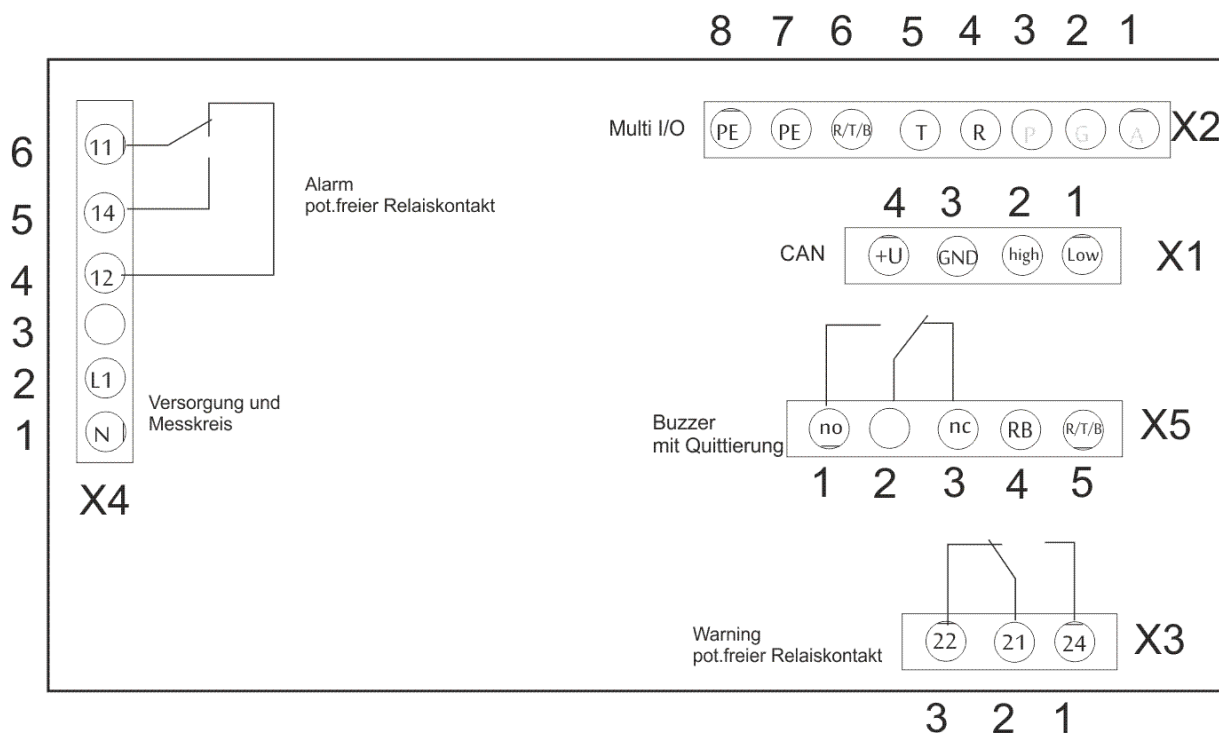

Illustration 3KWG-ISO5 allocation plan

### 7.3.2 KWG-ISO5 Pin assignment

Connection		Manufacturer	Type	Number of poles/spec.	Function
X1	X1.1	Tyco	AMP Mate-NLOK 350792-1	4-pole	CAN_Low
	X1.2				CAN_High
	X1.3				CAN_GND
	X1.4				VDD_CAN (12 - 24 V)
X2	X2.1	Tyco	AMP Mate-NLOK 641828-1	8-pole	Alarm OUT / optocoupler
	X2.2				Alarm OUT / GND
	X2.3				PWM OUT / optocoupler
	X2.4				Reset button
	X2.5				Test button
	X2.6				R/T/B centre (GND external)
	X2.7				PE1
	X2.8				PE2
X3	X3.1	Tyco	AMP Mate-NLOK 350789-1	3-pole	Relay warning / NO
	X3.2				Relay warning / Armature
	X3.3				Relay warning / NC
X4	X4.1	Tyco	AMP Mate-NLOK 641831-1	6-pole	Supply L1
	X4.2				Supply L2
	X4.3				Not used
	X4.4				Alarm / NC relay
	X4.5				Alarm / NO relay
	X4.6				Alarm / Armature relay
X5	X5.1	Tyco	AMP Mate-NLOK 643406-1	5-pole	Relay horn / NO
	X5.2				Relay horn / Armature
	X5.3				Relay horn / NC
	X5.4				Reset buzzer button
	X5.5				R/T/B centre (GND external)

Table 15KWG-ISO5 pin assignment

## 7.4 CAN interface

### 7.4.1 Hardware:

No terminating resistor (120 Ohm) is fitted as standard.  
The CAN interface is electrically isolated. For communication, a  
External supply voltage must be connected to X1 (U-GND).

### 7.4.2 CAN messages

#### 7.4.2.1 Overview

ID	DA/PS	PF	LEN	Description of the	TRIGGER	REF
0x0C286484	OC	40	8	Status flags, Iso Res, SW, Para	500 ms	7.4.2.2
0x0CC88464	ISO	200	0	ISO Test Command	if required	7.4.2.3
0x0CC98464	ISO	201	0	ISO Reset Command	if required	7.4.2.4
0x0CCA8464	ISO	202	0	ISO Buzzer Reset Command	if required	7.4.2.5
0x0CCB8464	ISO	203	1	ISO Cyclic Command - Test, Reset, Buzzer	if required	7.4.2.6

Table 16CAN - Overview

### NOTE

0x... = hexadecimal number

#### 7.4.2.2 ISO Guard - Status

ID	SA	DA	PDU format	Length	TRIGGER
0x0C286484	ISO	PC	40	8	500 ms

Table 17CAN - ISO monitor - Status

Byte 0	Byte 1	Byte 2	Byte 3	Byte 4	Byte 5	Byte 6	Byte 7
Status	ISO Resistance			SW Main	SW Sub	Par ID	

Table 18CAN - ISO monitor - Status - Byte

Byte 0	Status:	The bytes are described in the next chapter  7.4.2.2.1 described.
Byte 1-4	ISO Resistance:	Insulation resistance
Byte 5	SW Main	Software version - main version (e.g.: version 2.1)
Byte 6	SW Sub	Software version - sub-version
Byte 7	Par ID:	Parameter ID

Table 19CAN - ISO monitor - Status - Byte - Description

### 7.4.2.2.1 STATUS: ISO Status message

Byte 7	Byte 6	Byte 5	Byte 4	Byte 3	Byte 2	Byte 1	Byte
-	Calib	ParaDef	ParaNC	ParaMod	BuzzerOn	IsoWarn	IsoFault

Table 20CAN - STATUS: ISO status message

Byte 6	Calib:	Calibrated - The ISO value is calibrated.
Byte 5	ParaDef:	Parameter Default - Default parameter is active.
Byte 4	ParaNC:	Parameter Not Consistent - Error within the parameter.
Byte 3	ParaMod:	Parameter Modified - Occurs when the parameter has been changed.
Byte 2	BuzzerOn:	Buzzer is active - Occurs after ISO error.
Byte 1	IsoWarn:	Isolation Warning - Occurs when the isolation warning is activated. resistance < 46 kOhm <sup>1)</sup> is.
Byte 0	IsoFault:	Insulation Fault - Occurs when the resistance is too high. < 23 kOhm <sup>1)</sup> is.

Table 21CAN - STATUS: ISO status message - Description

<sup>1)</sup> May vary depending on design.

### 7.4.2.3 ISO Guardian - Command Test

ID	SA	DA	PDU format	Length	TRIGGER
0x0CC88464	PC	ISO	200	0	if required

Table 22CAN - ISO Monitor - Command Test

Send this command to start the ISO test. No user data required.

### 7.4.2.4 ISO Guard - Command Reset

ID	SA	DA	PDU format	Length	TRIGGER
0x0CC98464	PC	ISO	201	0	if required

Table 23CAN - ISO monitor - Command Reset

Send this command to reset the ISO test (reset). No user data required.

### 7.4.2.5 ISO Guard - Command Buzzer Reset

ID	SA	DA	PDU format	Length	TRIGGER
0x0CCA8464	PC	ISO	202	0	if required

Table 24CAN - ISO Monitor - Command Buzzer Reset

Send this command to reset the buzzer of the isowatcher. No user data required.

### 7.4.2.6 ISO Guard - Cyclic Command - Test, Reset, Buzzer

ID	SA	DA	PDU format	Length	TRIGGER
0x0CCB8464	PC	ISO	203	1	if required

Table 25CAN - ISO monitor - Cyclic Command - Test, Reset, Buzzer

Byte 0	Byte 1	Byte 2	Byte 3	Byte 4	Byte 5	Byte 6	Byte 7
Control	-	-	-	-	-	-	-

Table 26CAN - ISO-Watchdog - Cyclic Command - Test, Reset, Buzzer - Byte

Byte 0	Control	0 = no action 1 = Perform ISO test 2 = Perform ISO reset 3 = Execute ISO buzzer reset
--------	---------	--

Table 27CAN - ISO-Watchdog - Cyclic Command - Test, Reset, Buzzer - Byte - Description

This message can be called up cyclically. It contains the functionality of ISO test, ISO reset and buzzer reset in one message. This message was added in ISO software version V2.1.

### 7.4.3 Interface to the KWG iso-monitor / optional current transformer equipment

In addition to the stand-alone operating mode, the KWG insulation monitor offers the option of communicating with the KWG generator controller. The insulation value is output via the controller CAN bus. At the same time, the insulation value can be further processed in the KWG generator controller and used to control relays, for example. Independently of this, the insulation value can also be read directly from the CAN bus of the insulation monitor.

#### NOTE

The communication is compatible with earlier versions of the ISO guard.



## 7.5 Assembly

### 7.5.1 Flange mounting

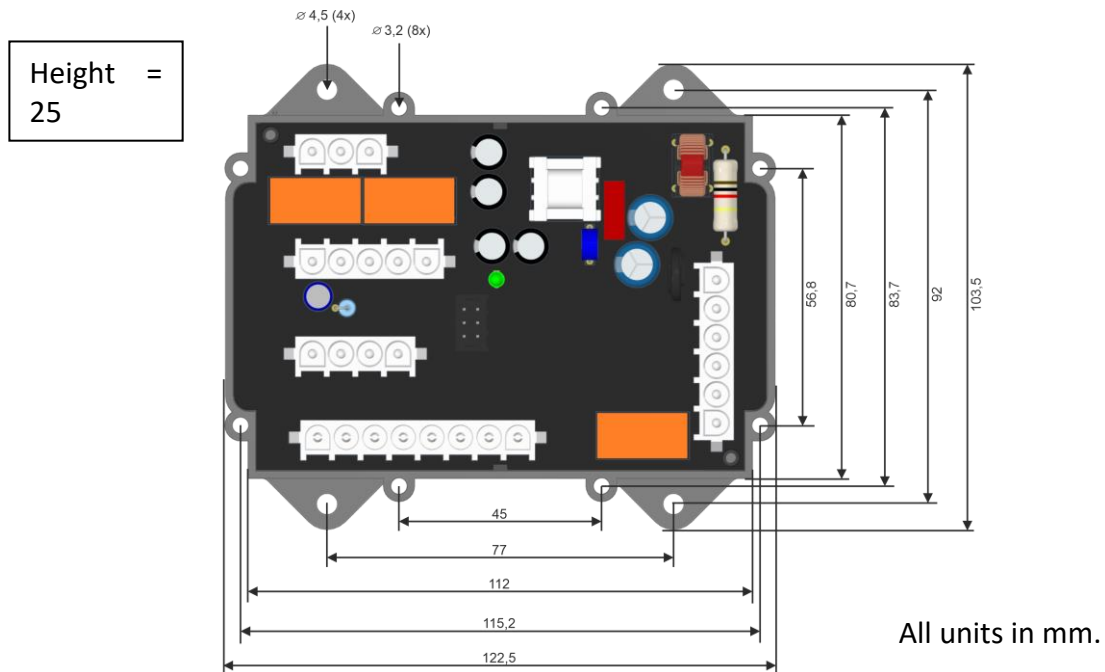
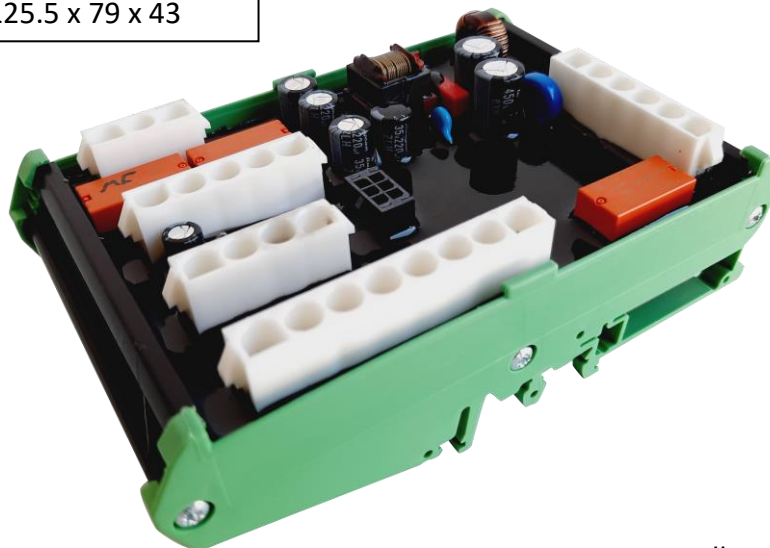

Illustration 4 Assembly - Flange mounting

### 7.5.2 DIN rail mounting

Dimensions: 125.5 x 79 x 43



All units in mm.

Illustration 5 Mounting - DIN rail mounting

## 7.6 Connection of the KWG-ISO5

### NOTE

The illustrations shown in the current chapter are symbolic images for connection examples of the KWG-ISO5 isowatcher.

### 7.6.1 All-pole disconnection with tripping device and with advance warning

Connection example Isowatcher KWG-ISO5.  
All-pole disconnection with tripping device and advance

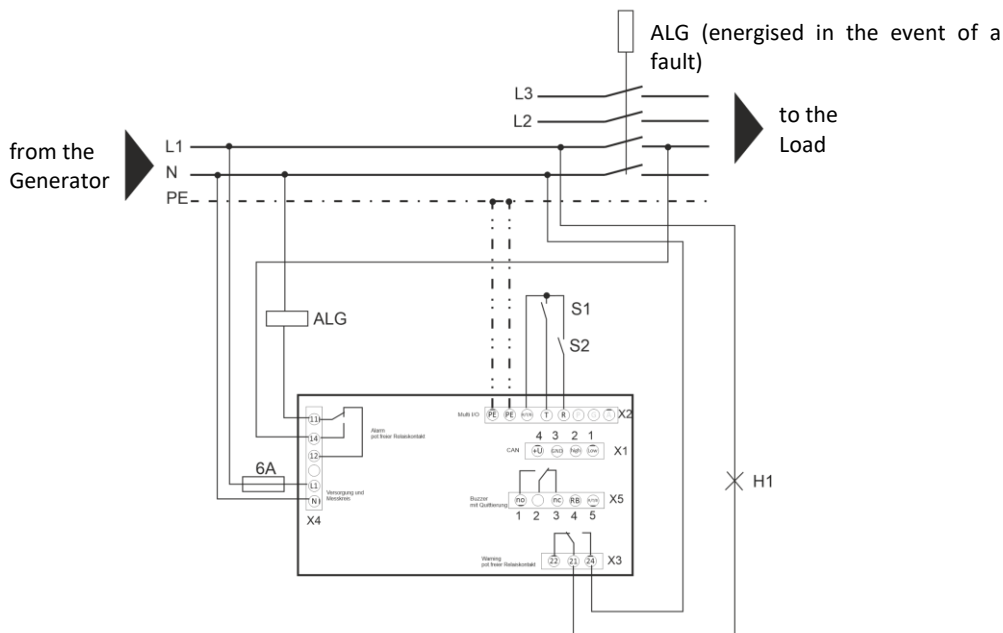

Illustration 6 Connection: All-pole disconnection with tripping device and with pre-warning

Description of the		
ALG:	Tripping device for miniature circuit breakers	
H1:	Indicator lamp 230 VAC (signal for advance warning)	
S1:	Test button (triggers the ISO error.)	
S2:	Reset button	Error is saved until the reset button is pressed.
Alarm:	Potential-free relay contact	Switches at $R_{ISO} < 23 \text{ k}\Omega$ *)
Warning:	Potential-free relay contact	Switches at $R_{ISO} < 46 \text{ k}\Omega$ *)
*) May vary depending on version.		

Table 28 Connection: All-pole disconnection with tripping device and with pre-warning

### 7.6.2 Monitoring with advance warning and alarm in vehicles

Connection example Isowatcher KWG-ISO5.  
All-pole disconnection with tripping device and advance

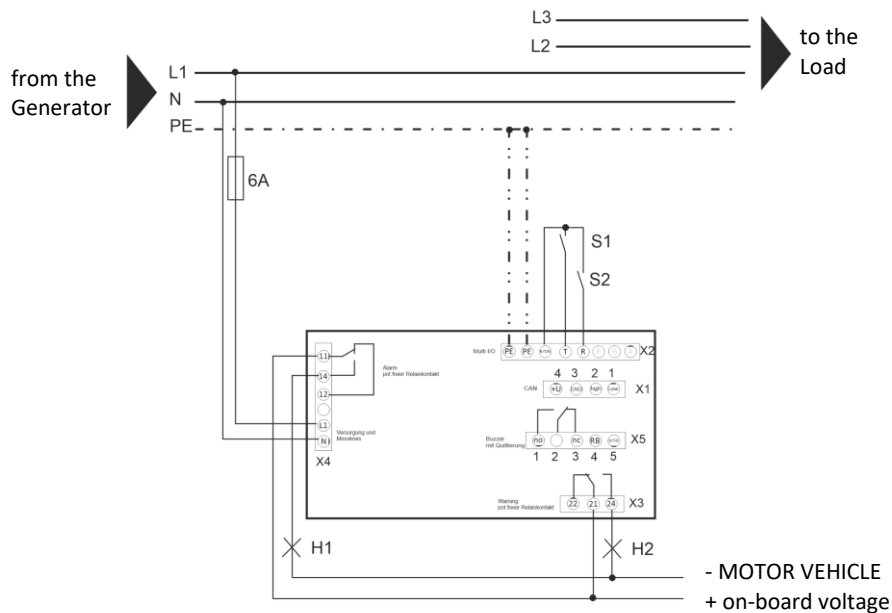

Illustration 7Connection: Monitoring with advance warning and alarm in vehicles

Description of the		
H1:	Indicator lamp 12 V / 24 V DC Alarm	
H2:	Indicator lamp 12 V / 24 V DC pre-warning	
S1:	Test button (triggers the ISO error.)	
S2:	Reset button	Error is saved until the reset button is pressed.
Alarm:	Potential-free relay contact	Switches at $R_{ISO} < 23 \text{ k}\Omega$ *)
Warning:	Potential-free relay contact	Switches at $R_{ISO} < 46 \text{ k}\Omega$ *)
*) May vary depending on version.		

Table 29Connection: Monitoring with advance warning and alarm in vehicles

7.6.3 All-pole disconnection with main contactor and with pre-warning

Connection example Isowatcher KWG-ISO5.  
All-pole disconnection with tripping device and advance

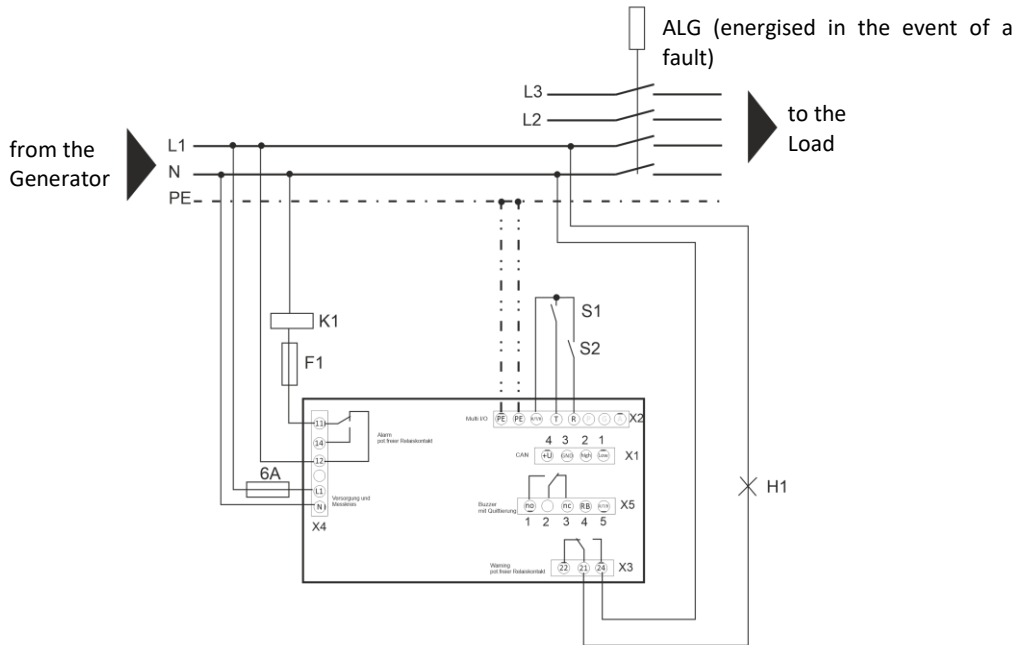

Illustration 8 Connection: All-pole disconnection with main contactor and with pre-warning

Description of the		
K1:	Main contactor	
H1:	Indicator lamp 230 VAC (signal for advance warning)	
S1:	Test button (triggers the ISO error.)	
S2:	Reset button	Error is saved until the reset button is pressed.
Alarm:	Potential-free relay contact	Switches at $R_{ISO} < 23 \text{ k}\Omega$ *)
Warning:	Potential-free relay contact	Switches at $R_{ISO} < 46 \text{ k}\Omega$ *)
*) May vary depending on version.		

Table 30 Connection: All-pole disconnection with main contactor and with pre-warning

## 8 MAINTENANCE



### DANGER



Dangerous electrical voltage

#### Death or serious injury due to electric shock

- Visual inspections and cleaning work on the KWG-ISO5 for maintenance purposes must never be carried out during operation.

### ATTENTION

#### Damage to components due to water ingress possible.

- Moisture and wetness on the circuit board of the KWG-ISO5 or on the circuit board encapsulation can destroy the KWG-ISO5. Cleaning the switch box or the switch cabinet with high-pressure cleaners is strictly prohibited.

All components of the KWG-ISO5 are maintenance-free. Damage and defects as well as excessive soiling on the KWG-ISO5 must be rectified immediately by authorised and qualified specialist personnel, regardless of the general / system warning intervals. Due to the full encapsulation, repair of the KWG-ISO5 is impossible and the entire KWG-ISO5 must be replaced. The entire system must not be put into operation until the defects have been rectified. Repair work may only be carried out by trained specialist personnel.

It may be necessary to carry out checks on the drive system in accordance with the specifications and regulations of the respective drive/system manufacturer. This also includes fitted protective covers.

Observe the maintenance instructions of the drive or system manufacturer. The generator may only be opened by KW-Generator GmbH or by an authorised service centre. It does not contain any parts that can be replaced or repaired by the user.

Before installing and commissioning the generator, carefully read the  chapter "3 Safety instructions".

## 9 TROUBLESHOOTING





### DANGER



Dangerous electrical voltage

#### Death or serious injury due to electric shock

- All work on electrical systems for troubleshooting / fault rectification may only be carried out by a qualified electrician.
- Always observe the Safety rules for working on electrical systems must always be observed -  see chapter 3.3.1.
- Use personal protective equipment -  see chapter 3.4.

### 9.1 Troubleshooting

This chapter describes troubleshooting if an ISO error occurs.  
The aim is to find the ISO error in the system.

- 1) Switch off the generator system.
- 2) Remove all electrical equipment (load) from the control box, switch box or generator and switch off all external devices.
- 3) Check that the entire electrical wiring of the system is correct and that there is no connection between "N" and "PE".
- 4) Commission the generator system (according to the instructions).
- 5) Determine error states with the aid of the indicator lights / CAN bus.
  - a) If a fault occurs, the ISO fault must be located in the alternator or in the switch box circuit. -> Contact KWG.
  - b) If no fault occurs, the ISO fault is to be found in the electrical equipment (load).
    - To do this, plug in or switch on each individual piece of electrical equipment step by step.  
Immediately label the electrical equipment (load) that causes an insulation fault when switching on as defective, disconnect it from the system and have it checked in a specialist workshop.

## 10 DECOMMISSIONING, UNINSTALLATION



### DANGER



Dangerous electrical voltage

#### Death or serious injury due to electric shock

- Before working on the appliance, it must be de-energised and disconnected from the power supply!
- Work on electrical systems and on the KWG-ISO5 may only be carried out when the system is switched off and de-energised. Switched-off drive units must be secured against unintentional restarting (including existing auxiliary circuits).
- Always observe the Safety rules for working on electrical systems must always be observed -  see chapter 3.3.1.



### WARNING

Danger from self-starting machines

#### Death or serious injury

- Before removing the KWG-ISO5, it must be ensured that the unit cannot be started automatically or manually.

### ATTENTION

#### Damage due to improper plug removal.

- When disconnecting the plugs, do not pull on the cable strands, as these can come loose from the plug contact and this can lead to an electrical interruption.

The KWG-ISO5 can be electrically disconnected by removing the AMP connectors.

### 11 REPAIR

No repair or maintenance work can be carried out on the KWG-ISO5 by the user. We strongly recommend that you remove the KWG-ISO5 for this work and send it to KW-Generator GmbH.



### 12 WASTE DISPOSAL

Observe the applicable legal regulations when disposing of or recycling generator systems that are no longer functional. If necessary, commission a disposal company. Further information can be obtained from the responsible environmental authorities or from KW-Generator GmbH as well as from the type-specific data sheet.

Designation	Material
KWG-ISO5	Disposal as industrial electronics scrap.  The KWG-ISO5 is lead-free and contains a hardened potting compound.
Housing material	ABS 1001 FR

Table 31Disposal

### **13 SPARE PARTS**

Please contact KW-Generator GmbH directly for spare parts due to the wide range of possible variants.